

Wyatt Orifice Flow Products
Machined and Fabricated Primary Elements

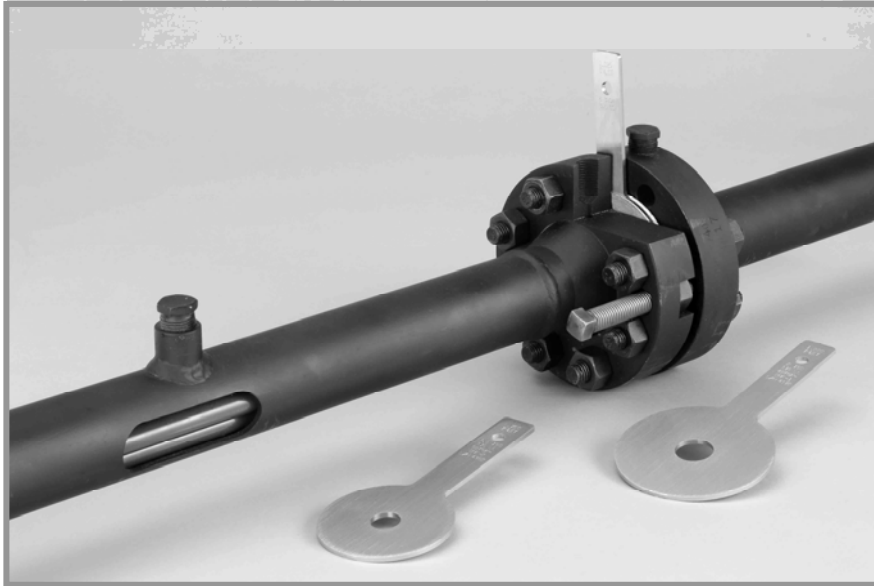

FEATURES:

- **Reliable Performance**
- **Low Installed Cost**
- **Wide Regulatory Acceptance**
- **Flexible Designs for Different Applications**
- **Well Documented**

Description

Differential pressure devices, specifically orifice plates, are used in flow measurement due to their simplicity, ease of installation, tolerance to extreme atmospheric and process conditions, and predictable and reliable performance. Orifice plates are the most common method of differential pressure flow measurement and are used in various industries, particularly in the hydrocarbon market. Due to their long history and dominance in the field of flow measurement, orifice plate designs and installation requirements have been well documented by national and international standards organizations.

Application

Wyatt Engineering orifice plates, flanges, and metering runs are used in a variety of applications where extremes of pressure, temperature, or the aggressive nature of the fluid being metered render other metering technologies unfeasible. Because of their reliability, low cost, and ease of installation, Wyatt orifice products are commonly used as the differential pressure device for the measurement of the flow of fluids, especially for clear water, steam, air, and most gases. Common installations include:

Natural Gas Transmission
Chemical and Pharmaceutical Processing
Power Generation
Refinery and Petrochemical

Documented Accuracy

Wyatt Engineering also provides application guidance to support the proper use of its equipment: Whether to use flange taps, corner taps, or pipe taps; whether a metering run with a flow straightener is necessary; whether to use a quadrant edge plate, or is another metering technology is required.

Unlike most providers of orifice products, Wyatt Engineering has extensive flow calibration data that reflects experience and depth of knowledge. Industry, national, and international codes can provide guidance to manufacturers, but only successful test results can assure the flow measurement results that are necessary in today's market.

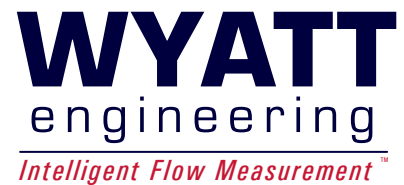

Technical Specifications

Accuracy

The uncertainty associated with the use of orifice meters is a function of pipe Reynolds number, beta ratio (d/D), tapping arrangement, line size, and piping configuration. Contact Wyatt Engineering for further information. If higher accuracy is desired, orifice flow meters can be flow calibrated to produce flow measurement uncertainties of $\pm 0.25\%$.

Headloss Comparison

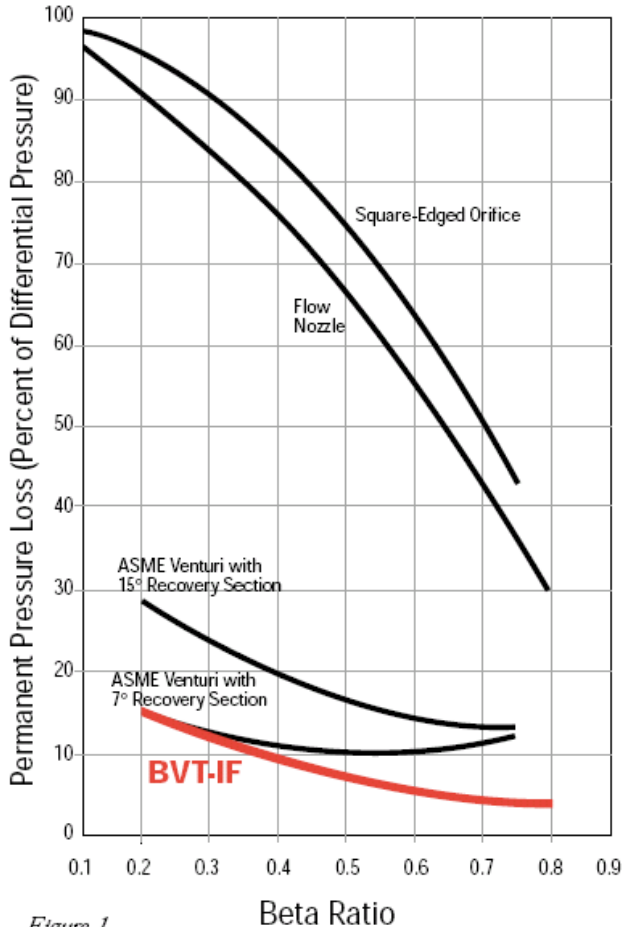

Figure 1

Pressure Loss

The permanent pressure loss of orifice plates, expressed as a percentage of the differential pressure produced, is somewhat higher than other differential producing primary elements. Refer to Figure 1, above.

Beta Ratio

Wyatt Engineering can furnish orifice meters with a wide range of diameter ratios (d/D). By custom designing a meter for your application's flow conditions, Wyatt can provide an accurate and reliable primary element.

Process & Environmental Conditions

Wyatt orifice plates, fittings, and meter runs can be fabricated for virtually any set of process or ambient conditions. We design to ASME B31.1, 31.3, 31.8, or other

standards, as needed. A temperature range of $-250\text{ }^{\circ}\text{C}$ to $+650\text{ }^{\circ}\text{C}$ ($-425\text{ }^{\circ}\text{F}$ to $+1200\text{ }^{\circ}\text{F}$) and pressures from vacuum service to 35 MPa (5100 PSIG) can be accommodated.

Piping Requirements

Designed for full-pipe flow, Wyatt Engineering orifice flow meters can be mounted horizontally, vertically, or at an angle. Refer to the appropriate code or contact Wyatt Engineering for recommended upstream and downstream piping and installation requirements.

Wyatt Orifice Flanges

While orifice plates produce differential pressures, properly manufactured orifice flanges are necessary to turn those differential pressures into a flow measurement. All Wyatt orifice flanges are manufactured in accordance with ANSI B16.36 (Orifice Flanges) and API 14.3.2/AGA Report 3 (Orifice Metering of Natural Gas). Wyatt orifice flanges are typically made of forged carbon steel; stainless steel, Cr-Mo alloys, and other materials are also available.

Flange Ratings from ANSI 150-lb raised-face to 2500-lb ring-type joint are available. ISO, DIN, and JIS flanges are also available.

Flange Bore Diameters and Surface Finishes are well within the tolerances given in the most recent industry, national, and international codes and standards.

Pressure Taps are typically 1/2" NPT, but other sizes and designs (socket-weld, flanged, etc.) are available. The taps are located in accordance with the most recent codes and standards. Tap hole centers are 23.813 mm (0.9375") from bearing faces of flanges, placing their centerlines 25.4 mm (1.00") from the face of the orifice plate when 1.588 mm (0.0625") compressed gasket thickness is considered. Piezometer hole edges are sharp and free from burrs.

Gaskets: Two precision-cut gaskets are furnished with all raised-face orifice flanges. For RTJ flanges, Wyatt Engineering provides integral plate holders for the pressure-retaining ring.

Flange Options

Jack Screws that allow for easier separation of the orifice flanges are our most-common option.

Alignment Pins that help assure proper alignment of the orifice plate with the flange bores can be furnished also.

Offset Tap Holes can be provided to provide greater clearance for transmitter impulse piping.

Vent Holes located at the highest elevation on the orifice flanges can be provided to allow for the bleeding-off of gases in liquid flow applications. **Drain Holes** located at the lowest elevation of the flanges can prevent liquids or condensates in gas or steam from being trapped behind the orifice plate.

Corner-Tap Orifice Flanges, most commonly used outside of North America, are also available. Corner tap flanges are used to measure fluids and gases in a variety of applications where economical and accurate orifice flow measurement is needed.

Orifice Specifications

OFF-CS: The standard **Concentric Sharp-Edged Orifice** plate is bored and beveled to a 45° angle. Wyatt Engineering's flow test data, as well as the requirements of most North American and international standards, indicate the cylindrical bore thickness should be limited to a range of 0.5% to 2.0% of the adjacent pipe inside diameter.

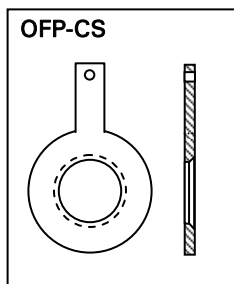

OFF-CU: Unlike the standard concentric plate, the **Concentric Unbeveled Orifice** plate is used for bidirectional flow measurement. This design can also be employed to restrict and limit flow rates, and help minimize cavitation in control valves and other equipment.

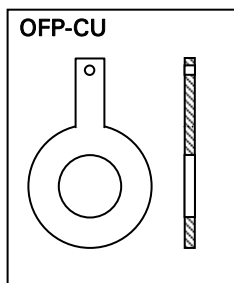

OFF-SO: **Segmental Orifice** plates can be used for the measurement of two-phase or multiphase flow (solids entrained in a liquid and/or gas flow stream; liquids entrained in a gas flow stream). Depending on the process flow, the segmental opening can be placed either at the crown or invert of the adjacent piping. This is a relatively common design in the chemical, pharmaceutical, pulp and paper, and petrochemical industries.

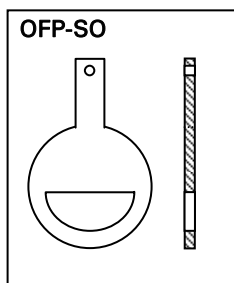

OFF-EO: The bores of **Eccentric Orifice** plates are not concentric with the pipe in which they are installed. The bore of the eccentric orifice is typically tangent to the inside diameter of the adjacent pipe. Like the segmental orifice plate, the bore can be placed at the top or bottom of the pipe and this design is relatively common in the chemical, pharmaceutical, pulp & paper, and petrochemical industries. Eccentric bore orifice plates are occasionally used when the application requires a very small bore and the process requires a vent or drain hole.

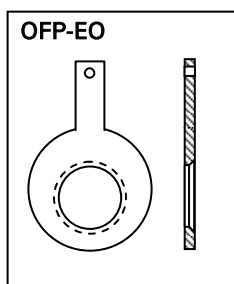

OFF-QE: **Quadrant Edge** orifice is not sharp-edged like the plates described above; rather, it is radiused. This design is for use with viscous process fluids, such as heavy crude or slurries where the pipe Reynolds number is normally less than 10 000. Since the radius of the bore's upstream edge is a function of the beta ratio, the plate thickness is typically greater than for standard concentric sharp-edged orifice plates.

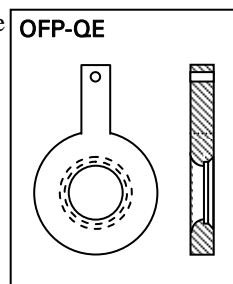

OFF-CO: Like the quadrant-edge plate, the **Conical Orifice** plate is designed for use with viscous fluids where the pipe Reynolds number is less than 10 000. The bore thickness is limited by counter-boring the downstream face.

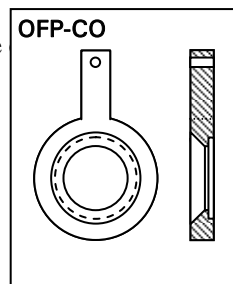

The typical materials for orifice plate construction are 304, 304L, 316, 316L stainless steels and carbon steel. Nickel and copper alloys, titanium, duplex stainless steels, PVC, PTFE, and other materials are also available.

The orifice plate thickness is chosen to limit plate deformation by taking into account the magnitude of the differential pressure and other defined stresses. Only under special circumstances will the plate thickness be less than 3 mm (0.120") nominal.

All Wyatt Engineering orifice plates are finished in accordance with the requirements of the applicable standards. Typically, the surface finish will not exceed 50 microinches, however, special finishes are available.

In order to measure the flow rate accurately, it is essential that the bore of the orifice plate be concentric with the internal diameter of the pipe. It is also necessary that the interior of the pipe be smooth and circular in cross section. When the nominal pipe size is larger than 65 mm (2½"), commercial pipe, flanges, etc., are typically within tolerance limits for accurate flow measurement. When the pipe diameter is 65 mm (2½") or less, however, greater care must be taken with the orifice installation smooth run of pipe upstream and downstream from the orifice.

Plate Options & Meter Runs

Orifice Options

Vent Holes located at the highest elevation on the orifice plate and tangent to the pipe inside diameter can be provided to prevent gases trapped in liquid flow from being dammed up behind the orifice plate. Similarly, **Drain Holes** located at the bottom of the plate can help prevent liquids or condensates in gas or steam from being trapped behind the orifice plate.

Special Coatings can be applied for particularly erosive or corrosive applications.

Special Finishes can be machined on the plate faces to cover the area between the pipe inside diameter to the outside diameter of the gasket seating surface. Special care should be taken that when specifying gasket finishes, use of thicker gaskets may be necessary that may, in turn, introduce flow measurement errors due to the larger-than-standard tap location dimensions.

Orifice Plate Carrier Assemblies are available for installations where it is too costly or otherwise inappropriate to employ standard orifice flanges.

Sanitary Orifice Plates, Multi-Hole Orifice Plates, and Multistage Restriction Orifice Runs are also available.

Wyatt Orifice Meter Runs

Wyatt Engineering provides complete **Orifice Meter Runs** that include the orifice plate, orifice flanges, upstream and downstream piping, and (if required) straightening vanes or flow conditioners. Our flow meter runs are designed to ASME B31.1 (Power Piping), B31.3 (Process Piping), or B31.8 (Gas Transmission Piping) and comply with the metering requirements of AGA 3, API 14, ASME MFC 3M, ASME MFC 14M, and/or ISO 5167. Ends of the meter run can be threaded, beveled for welding, or furnished with flanges (150-lb through 2500-lb) to suit the application requirements. Certified material and dimensional inspection reports are provided with every meter run.

For line sizes between 12 mm (½") and 40 mm (1½"), Wyatt Engineering provides its **Honed Orifice Metering Section**. Used in applications requiring high accuracy in the measurement of low flow rates, these meter runs are used most often in specialty gas and cryogenic applications. Given their size and sensitivity to corrosion, all honed orifice metering sections are fabricated of stainless steel as a standard, but other materials are available.

