

Wyatt Flow Nozzle Products
Machined and Fabricated Primary Elements

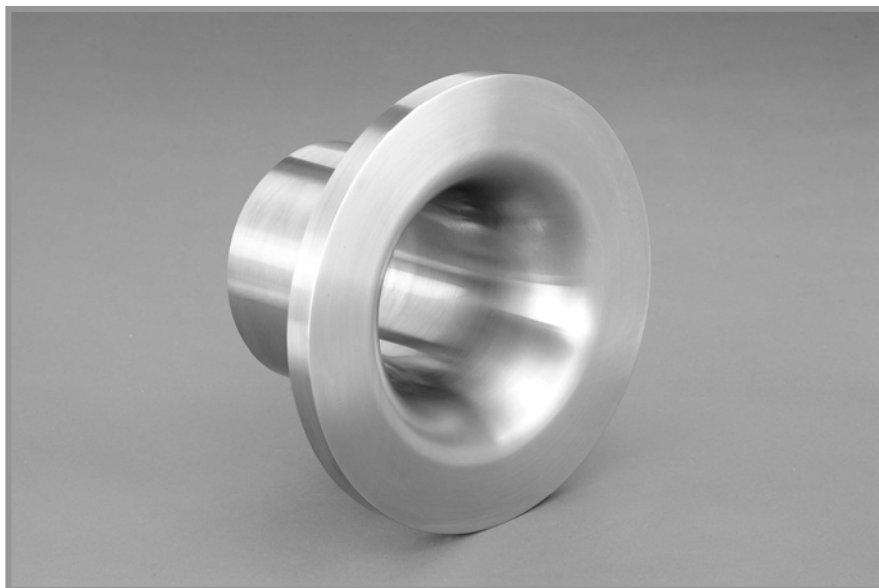

FEATURES:

- Long Term Reliability
- Widely Accepted
- Low Installed Cost
- Well Documented
- Flexible Designs for Different Applications

Description

Flow nozzles are often used in flow measurement due to their reliable performance and tolerance to extremes in process and environmental conditions. They offer advantages over orifice plates in that they require less upstream piping and incur lower permanent pressure loss. Accuracy can be sustained indefinitely since there are no sharp edges to wear.

Wyatt Engineering flow nozzles are used in various industries, particularly for steam flow in the power sector. Due to their long documented history, flow nozzle designs and installation requirements are known and recognized by national and international standards organizations.

Application

Wyatt Engineering flow nozzles and metering runs are used in a variety of applications where extremes of pressure, temperature, or the aggressive nature of the fluid being metered render other metering technologies unfeasible. Because of their long-term reliability and ease of installation, Wyatt nozzle products are commonly used as the differential pressure device for the measurement of the flow of fluids, especially for water, steam, air, and gases. Common installations include:

- Power Plants
- Refineries
- Petrochemical Plants
- Chemical Processing Facilities
- Steam and Condensate Flows

Documented Accuracy

Unlike most providers of flow nozzles products, Wyatt Engineering has extensive flow calibration data that reflects experience and depth of knowledge. Industry, national, and international codes can provide guidance to manufacturers, but only successful tests can assure the flow measurement results that are necessary in today's market.

Wyatt Engineering also provides application guidance to support the proper use of its equipment: Whether to use a flanged nozzle or a weld-in design; whether a metering run with a flow straightener is necessary; whether the use of a PTC-6 test section is warranted, or if another metering technology is required.

F
N
P

g
/
0
9

P
R
E
P
U
B

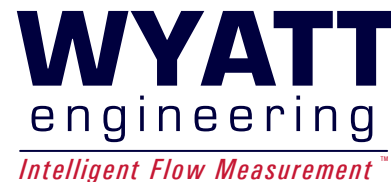
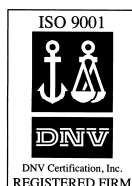

Technical Specifications

Accuracy

The uncertainty of flow nozzles is a function of design, pipe Reynolds number, beta ratio (d/D), and piping configuration. Contact Wyatt Engineering for further information. If higher accuracy is desired, the flow nozzles can be flow calibrated to produce flow measurement uncertainties of $\pm 0.25\%$.

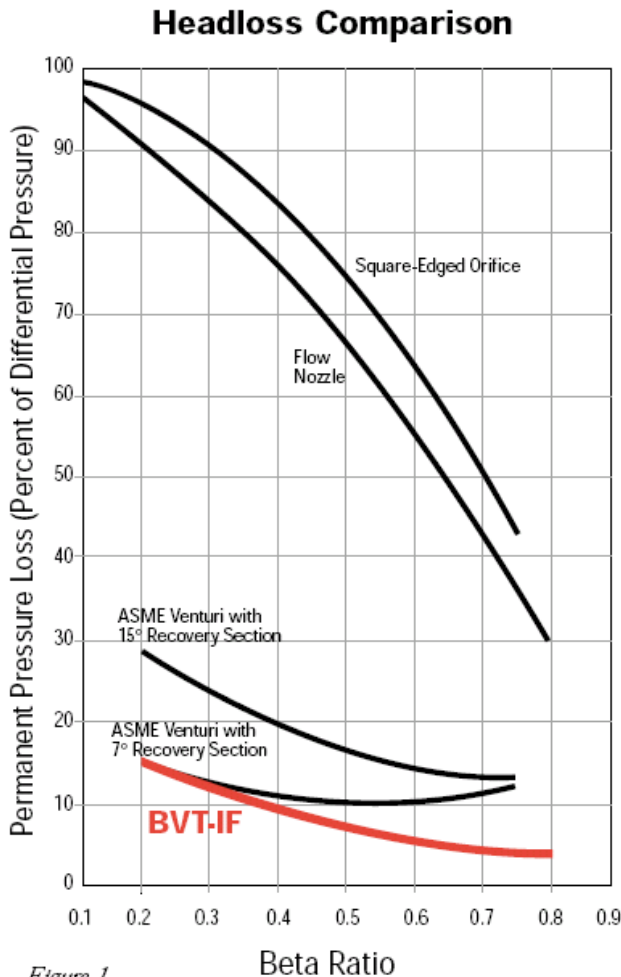

Figure 1

Pressure Loss

The permanent pressure loss of flow nozzles, expressed as a percentage of the differential pressure produced, though not as high as orifice meters, is significantly higher than the other differential producing primary elements shown in Figure 1, above.

Beta Ratio

Wyatt Engineering furnishes flow nozzles with a wide range of diameter ratios (d/D). By custom designing a meter for your application's flow conditions, Wyatt can provide an accurate and reliable primary element.

Process & Environmental Conditions

Wyatt flow nozzles and meter runs can be fabricated for virtually any set of process and ambient conditions. We design to ASME B31.1, 31.3, 31.8, or other standards, as needed. A temperature range of $-250\text{ }^{\circ}\text{C}$ to $+650\text{ }^{\circ}\text{C}$ ($-425\text{ }^{\circ}\text{F}$ to $+1200\text{ }^{\circ}\text{F}$) and pressures from vacuum service to 35 MPa (5100 PSIG) can be accommodated.

Piping Requirements

Designed for full-pipe flow, Wyatt Engineering flow nozzles can be mounted horizontally, vertically, or at an angle. Refer to the appropriate standard or contact Wyatt Engineering for recommended upstream and downstream piping and installation requirements.

Wyatt Engineering Flow Nozzles

- Flanged, Weld-In, and Pipe-Ring Types
- In Conformance with National and International Codes, as required
- Available in Stainless Steels, Nickel Alloys and Copper Alloys, and Other Materials
- Available as Fully Assembled Metering Runs ("Meter Tubes" and "Test Sections")

Wyatt Engineering manufactures a full line of precision flow nozzles for a wide variety of applications and installations. Most commonly used for steam, condensate, and gas flow applications, all Wyatt flow nozzles are made to conform to the applicable ASME, ISO, DIN, ISA 1932, or ASHRAE code. Nozzles are available for installation in 25 mm (1") pipe and larger, and specially designed nozzle flow section assemblies are available as well.

For most applications, flow nozzles should be made of stainless steel or other corrosion- and scale-resistant material in order to maintain their performance over extended periods. The typical materials for nozzle construction are 304, 304L, 316, 316L stainless steels and carbon steel. Nickel and copper alloys, titanium, duplex stainless steels, PVC, and PTFE. Chrome-Molybdenum alloyed steel flow nozzles are available for use in high temperature/high pressure process conditions. Other materials are available for corrosives and extreme applications.

Energy Considerations

As can be seen in Figure 1, the energy consumption of flow nozzles is considerably higher than that for ASME venturi meters; more so when compared to the BVT design. In fact, employing BVT venturi meters will lower permanent pressure loss and energy usage to about one-tenth of that associated with the use of a flow nozzle. Alternately, Wyatt Engineering can provide a diffuser cone on the outlet of the nozzle to lower the losses associated with its use.

Flow Nozzle Specifications

Flanged Flow Nozzles

Flanged flow nozzles are constructed with a mounting flange in line with the contoured upstream face. The mounting flange is sandwiched between the end-user's pipe flanges to hold and seal the flow nozzle inside of the process piping. The mounting flange can be provided with a raised gasket face or RTJ groove, as required. Every flanged flow nozzle has a precision-machined shoulder to help assure its concentricity with the adjacent pipe.

The Wyatt Engineering **Flanged Flow Nozzle** is installed between pipe flanges when the customer/end-user is providing the taps for the upstream and downstream pressure sensation. The flow contour is machined to ASME or ISO specifications and a shoulder is provided on the downstream side of the mounting flange to center the nozzle within required tolerances.

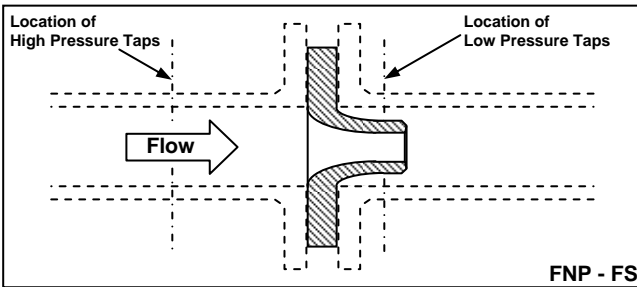

Note that the high pressure tap is nominally placed one pipe inside diameter (D) upstream from the nozzle face and the low pressure tap is located one-half a pipe diameter ($D/2$) downstream from the nozzle face. Given this tapping configuration, several combinations of line size and flange geometry may preclude proper tap placement or violate certain piping and pressure vessel codes. Inform your Wyatt Engineering representative if this is the case, and we will provide special designs to solve the problem.

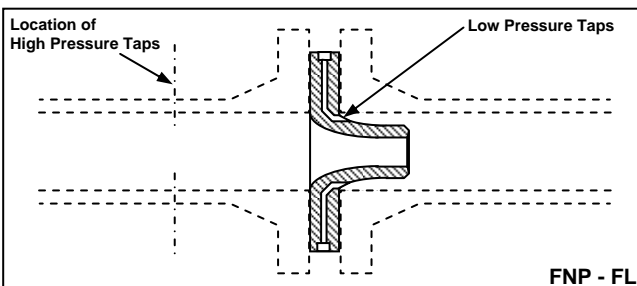

The Wyatt **Flanged Flow Nozzle with Integral Low Pressure Tap** is provided with the downstream tap integral to the nozzle's mounting flange. This design provides the same ASME or ISO flow contour, but can be used in smaller pipe sizes where the low pressure tap may interfere with the pipe weld, flange, and/or flange bolting. The low pressure connection is typically 1/4" NPT (6 mm) unless specified otherwise.

Weld-In Flow Nozzles

Wyatt Engineering's **Weld-In Flow Nozzle** is used where pipe flanges are not or cannot be used, such as in high pressure and/or high temperature applications in power plant installations. This flow nozzle design has a small mounting

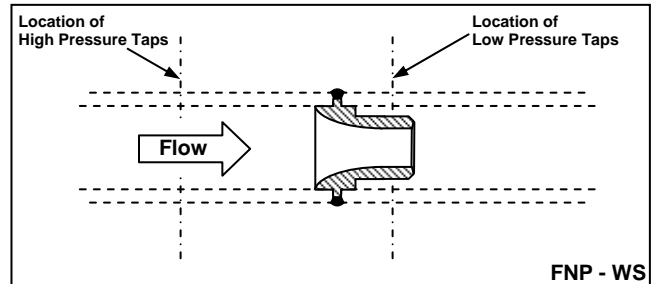

flange designed to fit between beveled ends of the inlet and outlet pipe section. The pipe sections are then welded together with the nozzle in place.

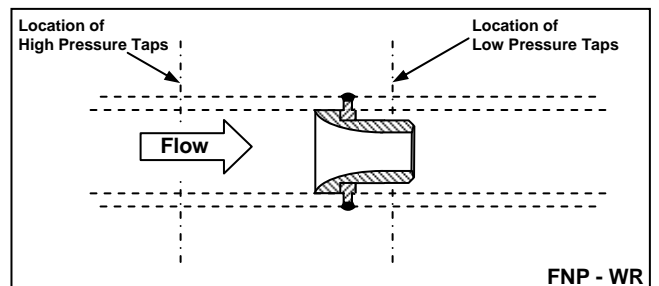

The weld-in flow nozzle design can be provided as a special **Mounting Ring Flow Nozzle** that eliminates the need for welding dissimilar metals in the field. Note that pipe wall pressure taps are used with this nozzle design and that it is available in complete flow metering section.

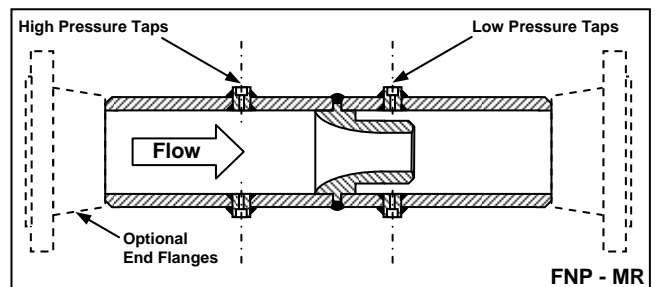

For special applications and in smaller line sizes, Wyatt Engineering provides a **Weld-In Flow Nozzle with Integral Metering Taps**. This design may include a short section of upstream and downstream pipe with flanged, beveled, or socket-weld ends.

Throat Tap Nozzles & Test Sections

For the power sector and for performance testing, Wyatt Engineering manufactures the well-recognized ASME **Throat Tap Flow Nozzle**. This design is often used as the acceptance test flow meter for power plants. In many cases, the throat tap flow nozzle is provided with the complete upstream and downstream piping, and integral flow straightener, and is flow calibrated in a suitable, independent flow test facility.

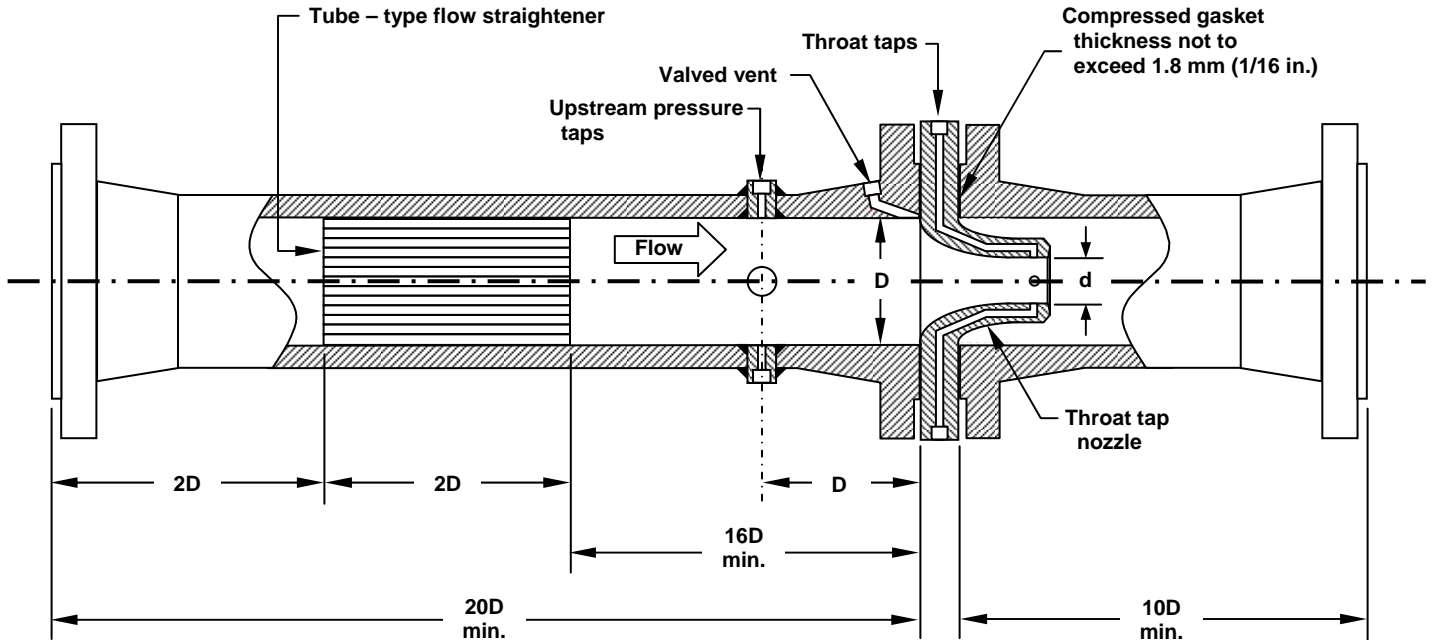
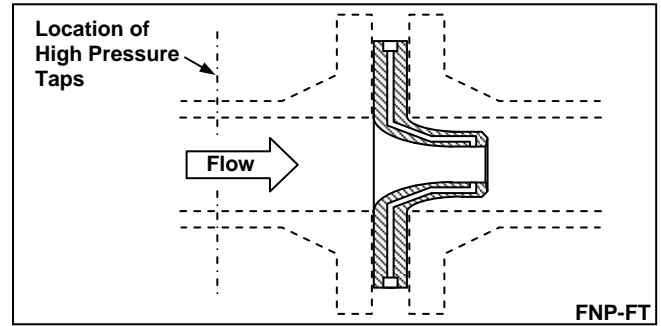

PTC-6 Test Section with Tube-Type Flow Straightener

FNP-TS

Wyatt Engineering's **PTC-6 Test Section** is manufactured in conformance with the design given in the ASME Performance Test Code. These units are most often utilized in boiler feedwater applications in power plant where the throat Reynolds numbers are high ($R_d > 10^7$). Test sections are usually flow calibrated by an independent test facility and, depending on size and application, a $\pm 0.25\%$ uncertainty band is attainable. Permanent pressure loss can be reduced by an optional diffuser section installed downstream of the nozzle.

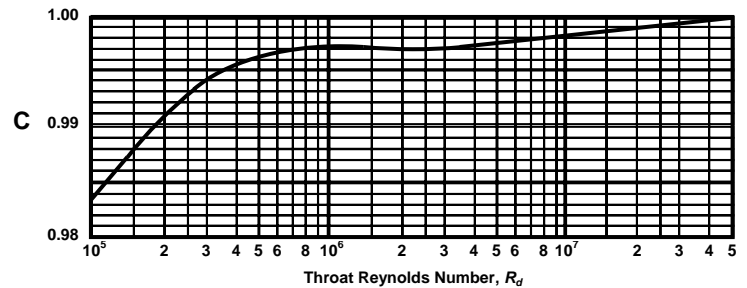

Reference Curve for Nozzle Calibration

